

Attachment A5

**Urban Design Report – Bates Smart - 15-25
Hunter and 105-107 Pitt Street, Sydney-
Part 4**

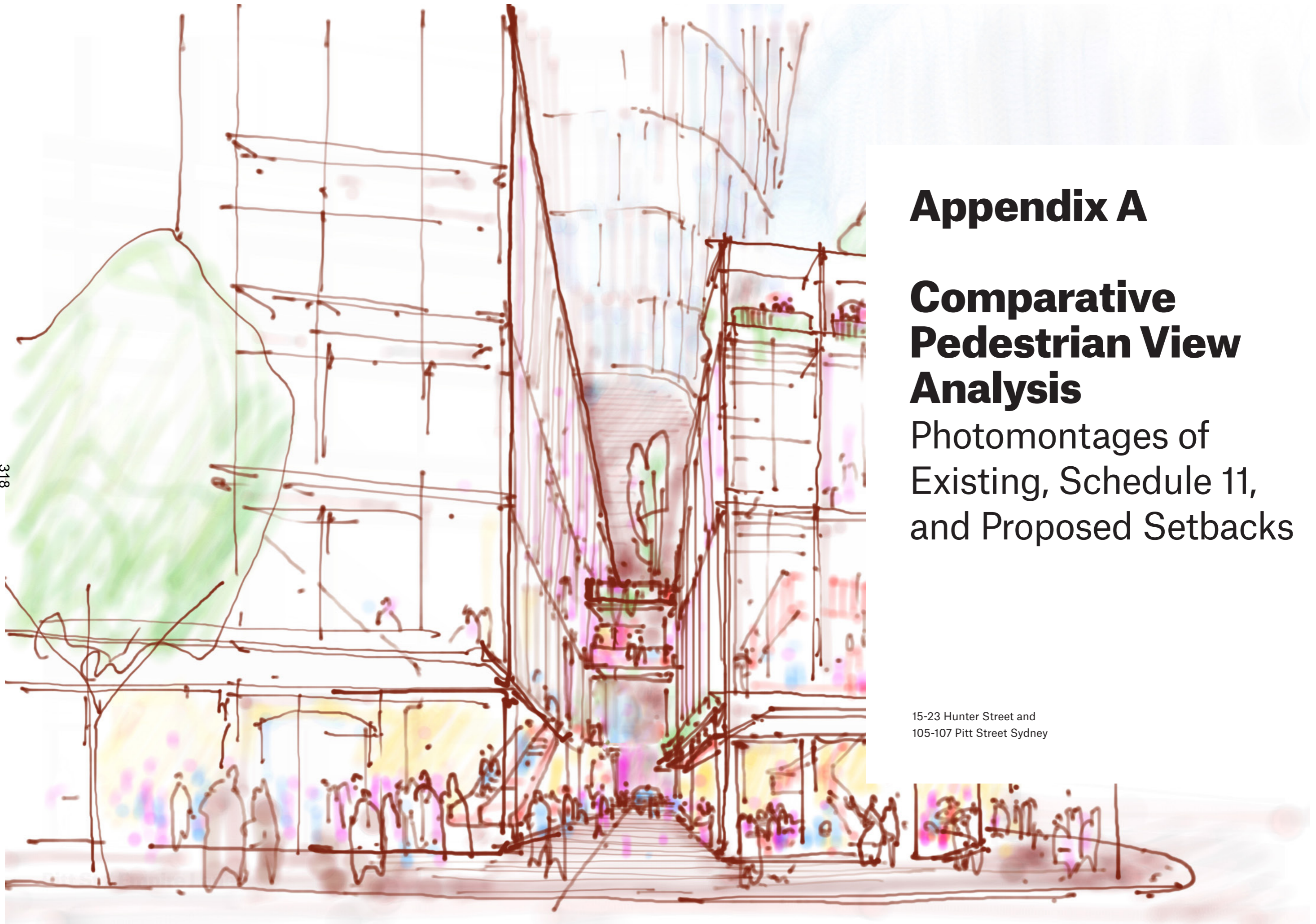

Appendix A

Comparative Pedestrian View Analysis

Photomontages of
Existing, Schedule 11,
and Proposed Setbacks

15-23 Hunter Street and
105-107 Pitt Street Sydney

COMPARATIVE PEDESTRIAN VIEW ANALYSIS

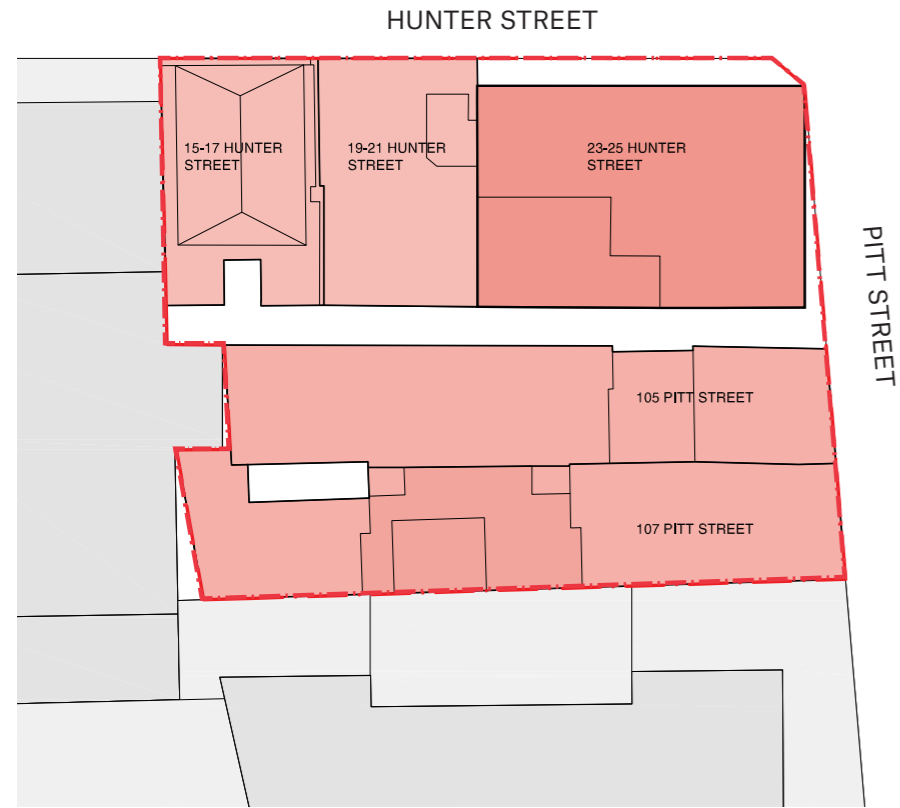

EXISTING SITE CONTEXT

319

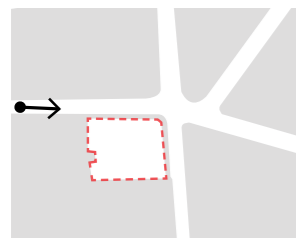

VIEW 1 - Looking east along Hunter Street



COMPARATIVE PEDESTRIAN VIEW ANALYSIS

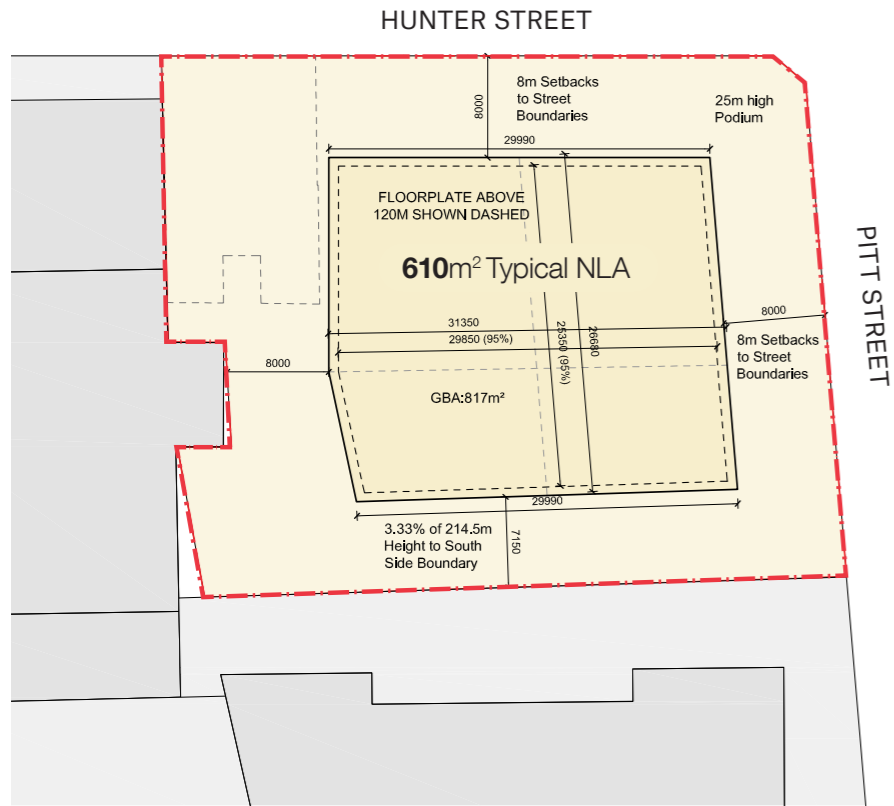

SCHEDULE 11 ENVELOPE TOWER SETBACKS

Pitt Street	8m
Hunter Street	8m
Western Boundary	8m
Southern Boundary	7.15m

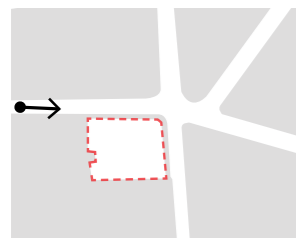

VIEW 1 - Looking east along Hunter Street



COMPARATIVE PEDESTRIAN VIEW ANALYSIS

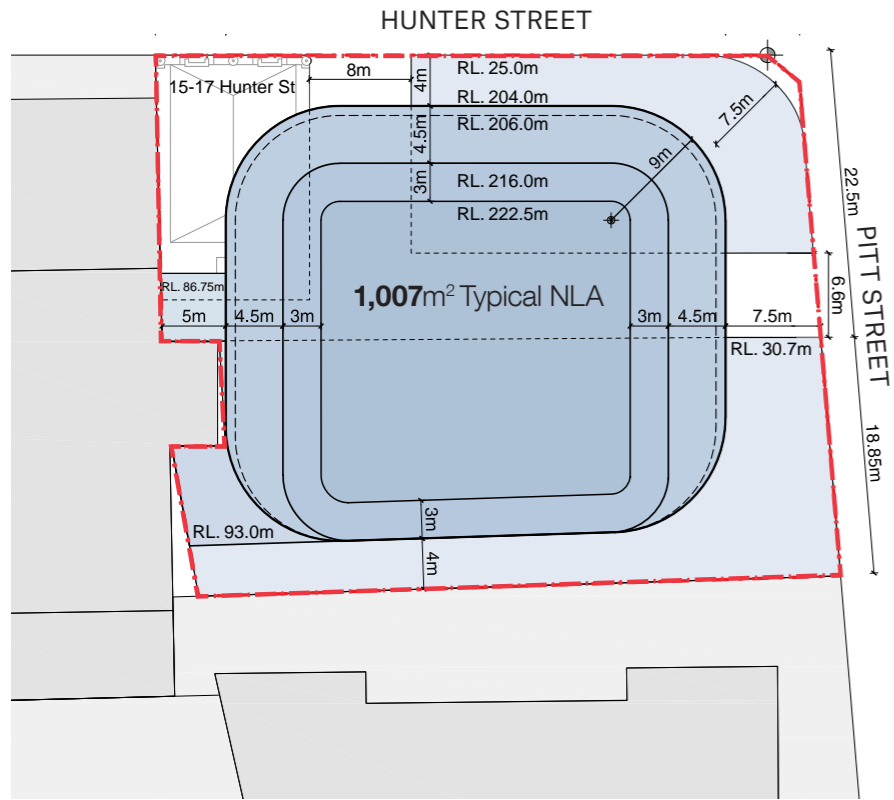

PROPOSED ENVELOPE TOWER SETBACKS

Pitt Street	7.5m average
Hunter Street	4m
Western Boundary	5.5m max.
Southern Boundary	4m

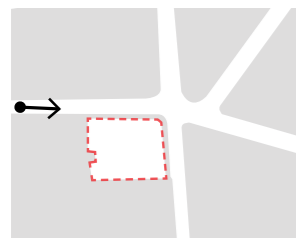

VIEW 1 - Looking east along Hunter Street



COMPARATIVE PEDESTRIAN VIEW ANALYSIS

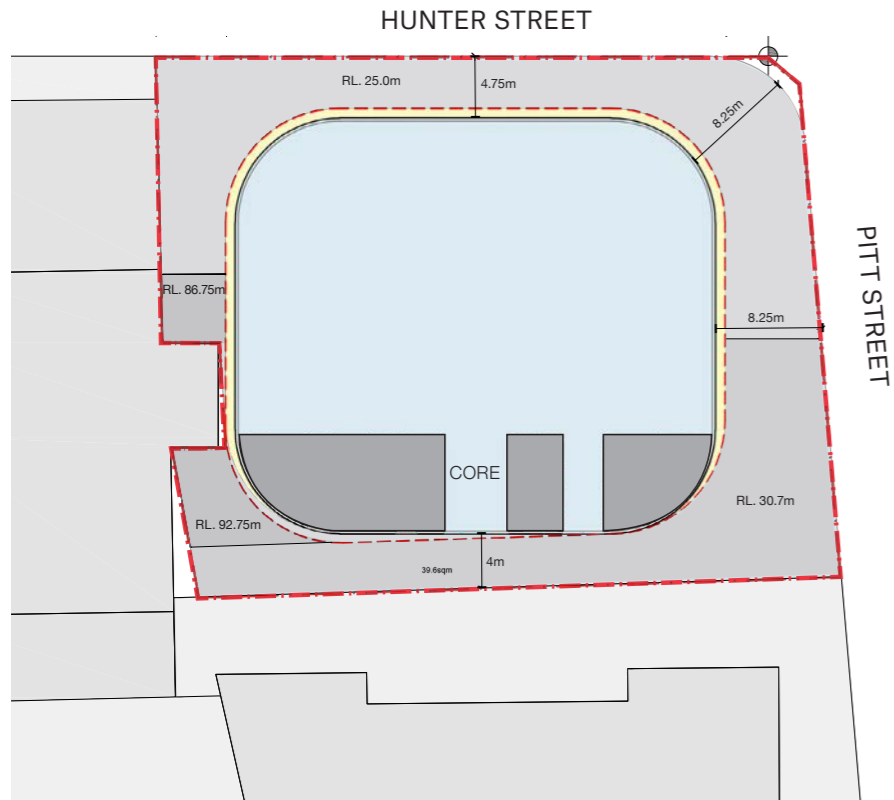

REFERENCE DESIGN TOWER SETBACKS

Pitt Street	8.25m average
Hunter Street	4.75m
Western Boundary	6.25m max.
Southern Boundary	4m

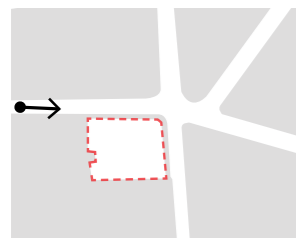

VIEW 1 - Looking east along Hunter Street



COMPARATIVE PEDESTRIAN VIEW ANALYSIS

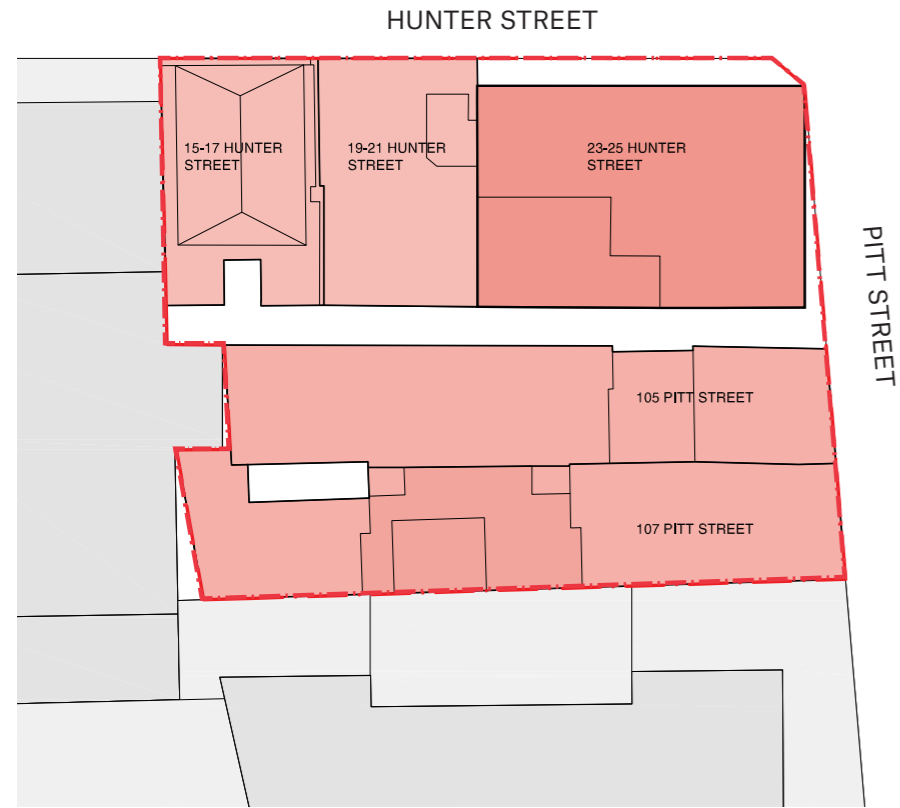

EXISTING SITE CONTEXT

323

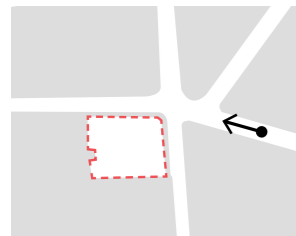

VIEW 2 - Looking west along Hunter Street



COMPARATIVE PEDESTRIAN VIEW ANALYSIS

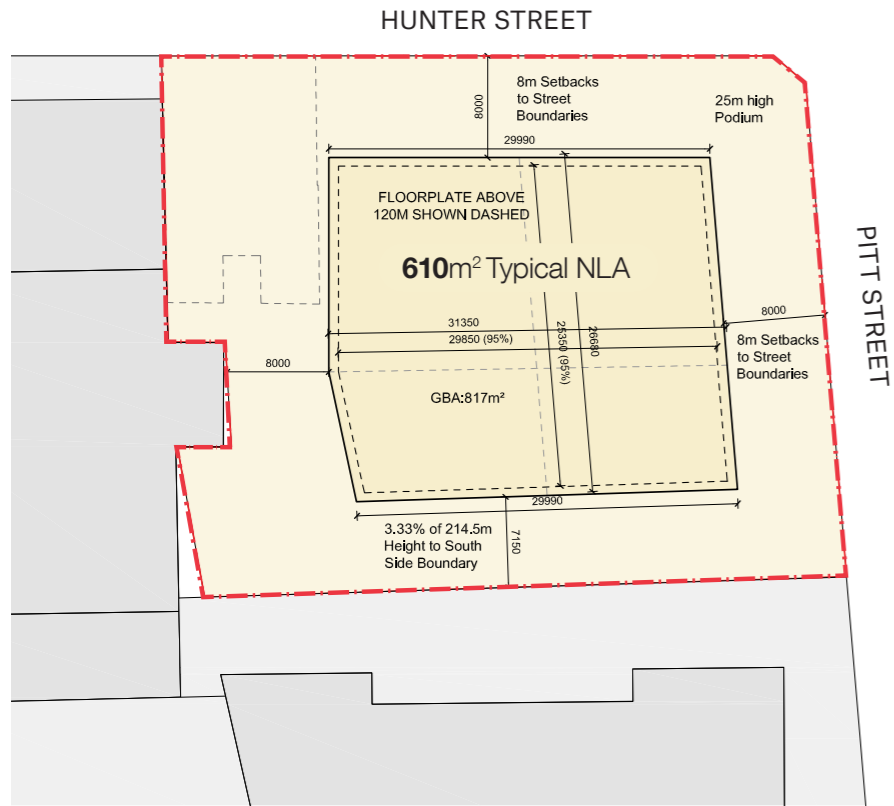

SCHEDULE 11 ENVELOPE TOWER SETBACKS

Pitt Street	8m
Hunter Street	8m
Western Boundary	8m
Southern Boundary	7.15m

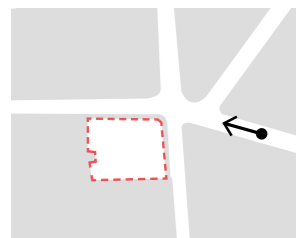

VIEW 2 - Looking west along Hunter Street



COMPARATIVE PEDESTRIAN VIEW ANALYSIS

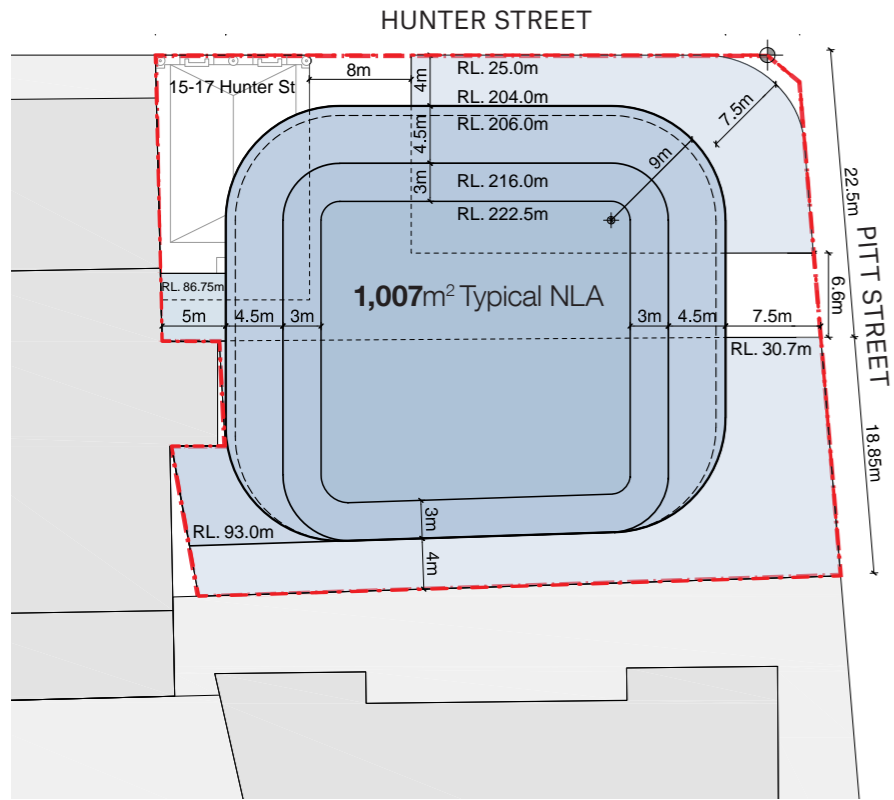

PROPOSED ENVELOPE TOWER SETBACKS

Pitt Street	7.5m average
Hunter Street	4m
Western Boundary	5.5m max.
Southern Boundary	4m

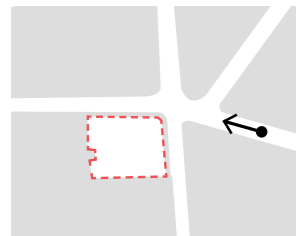

VIEW 2 - Looking west along Hunter Street



COMPARATIVE PEDESTRIAN VIEW ANALYSIS

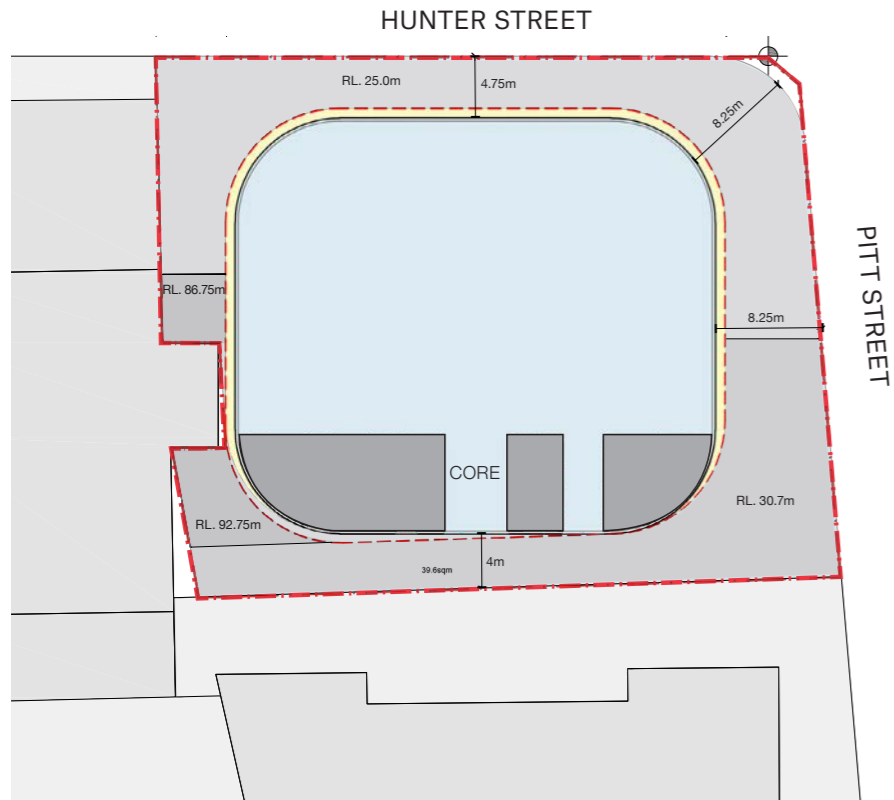

REFERENCE DESIGN TOWER SETBACKS

Pitt Street	8.25m average
Hunter Street	4.75m
Western Boundary	6.25m max.
Southern Boundary	4m

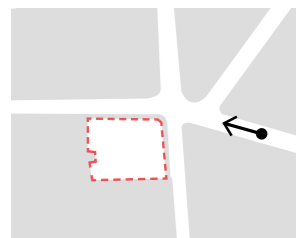

VIEW 2 - Looking west along Hunter Street



COMPARATIVE PEDESTRIAN VIEW ANALYSIS

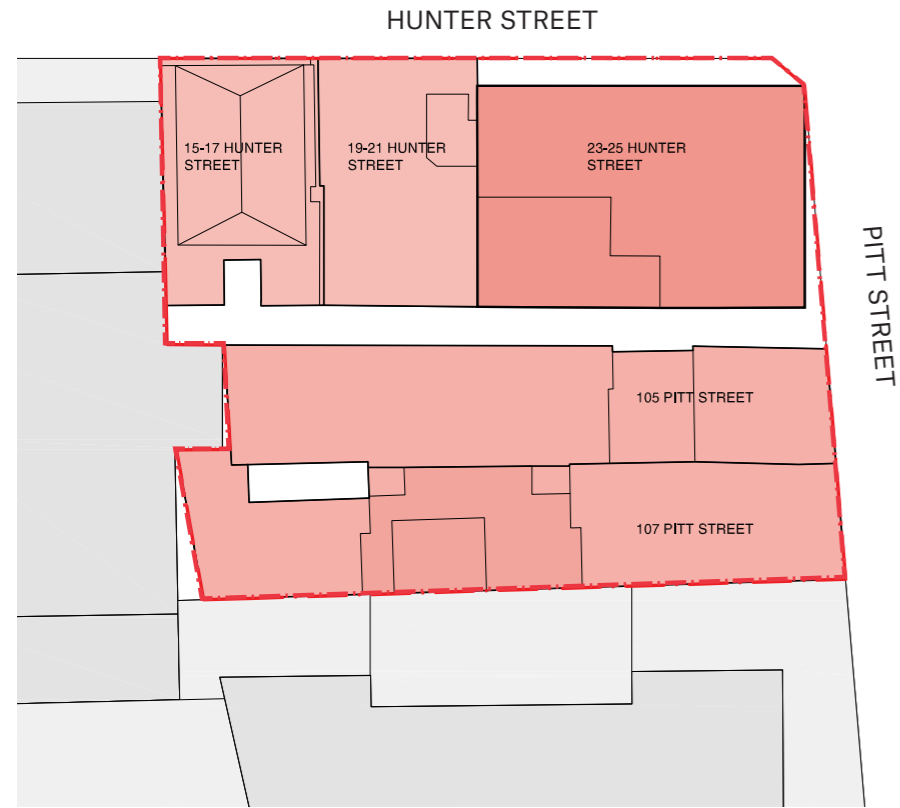

EXISTING SITE CONTEXT

327

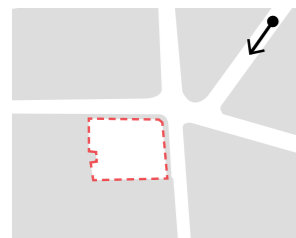

VIEW 3 - Looking south-west along O'Connell Street



COMPARATIVE PEDESTRIAN VIEW ANALYSIS

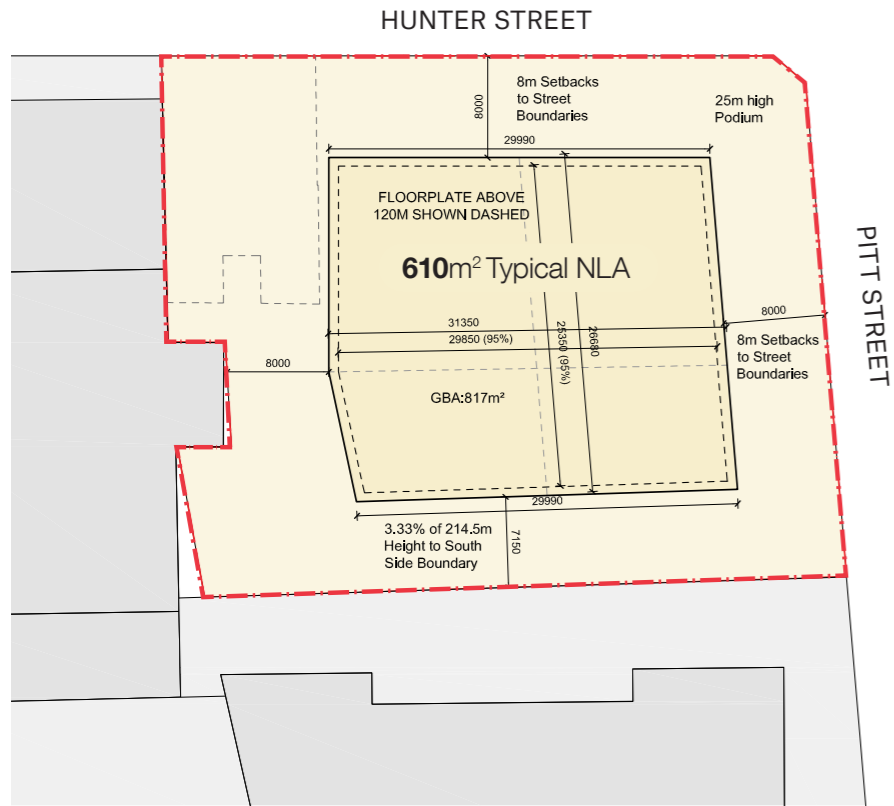

SCHEDULE 11 ENVELOPE TOWER SETBACKS

Pitt Street	8m
Hunter Street	8m
Western Boundary	8m
Southern Boundary	7.15m

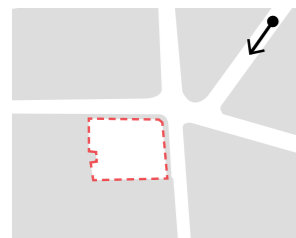

VIEW 3 - Looking south-west along O'Connell Street



COMPARATIVE PEDESTRIAN VIEW ANALYSIS

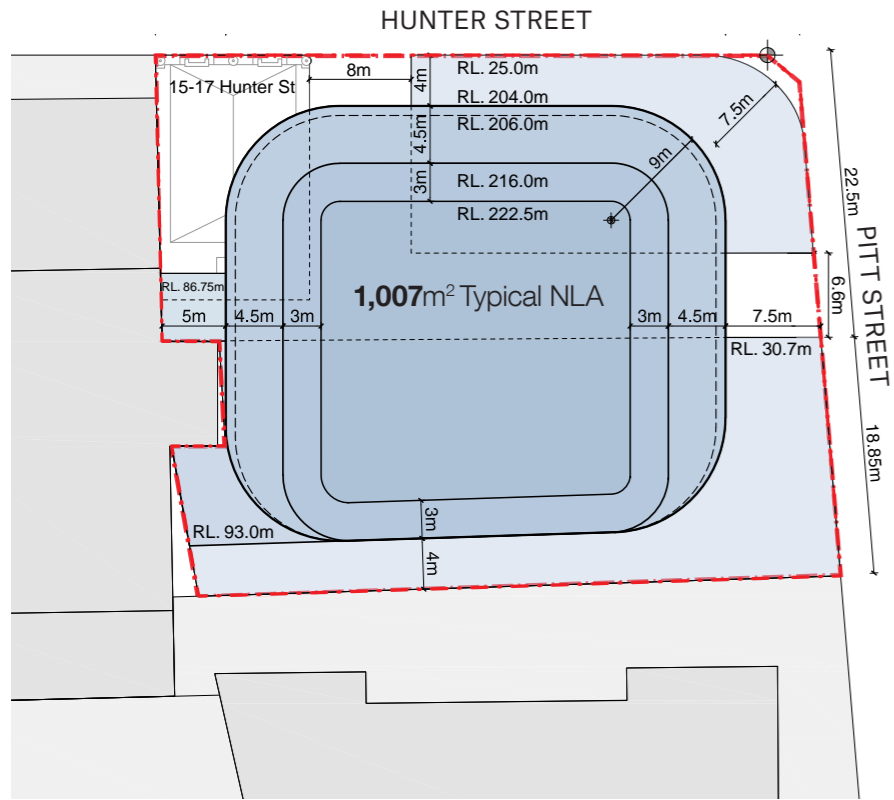

PROPOSED ENVELOPE TOWER SETBACKS

32 Pitt Street	7.5m average
Hunter Street	4m
Western Boundary	5.5m max.
Southern Boundary	4m

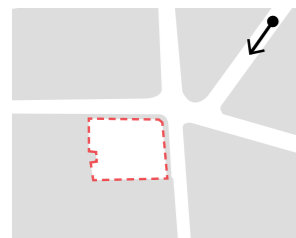

VIEW 3 - Looking south-west along O'Connell Street



COMPARATIVE PEDESTRIAN VIEW ANALYSIS

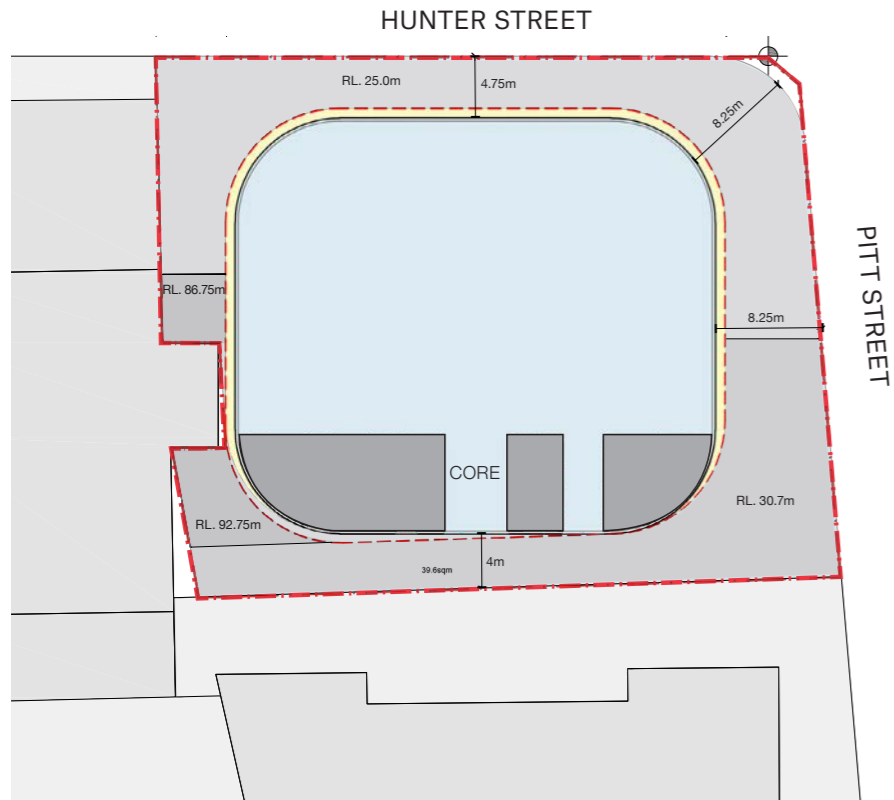

REFERENCE DESIGN TOWER SETBACKS

330 Pitt Street	8.25m average
Hunter Street	4.75m
Western Boundary	6.25m max.
Southern Boundary	4m

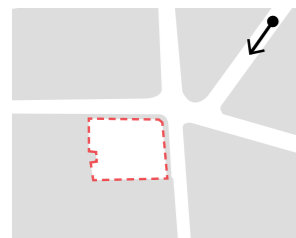

VIEW 3 - Looking south-west along O'Connell Street



COMPARATIVE PEDESTRIAN VIEW ANALYSIS

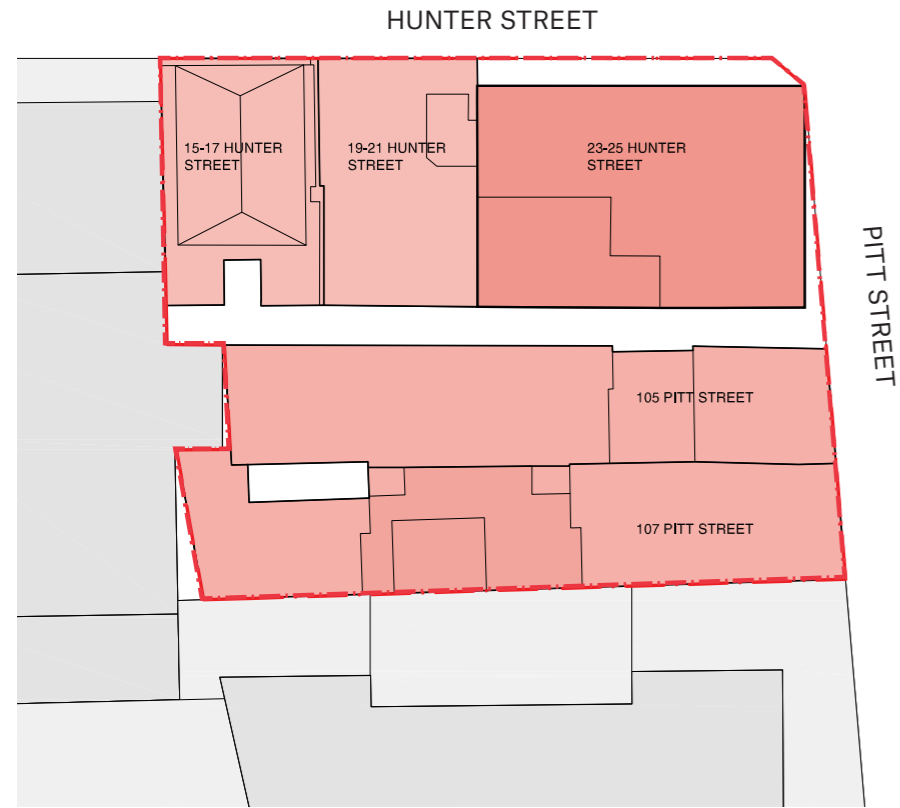

EXISTING SITE CONTEXT

331

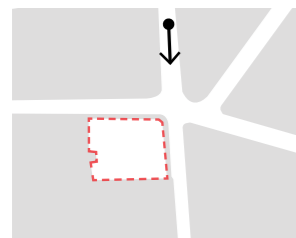

VIEW 4 - Looking south along Pitt Street



COMPARATIVE PEDESTRIAN VIEW ANALYSIS

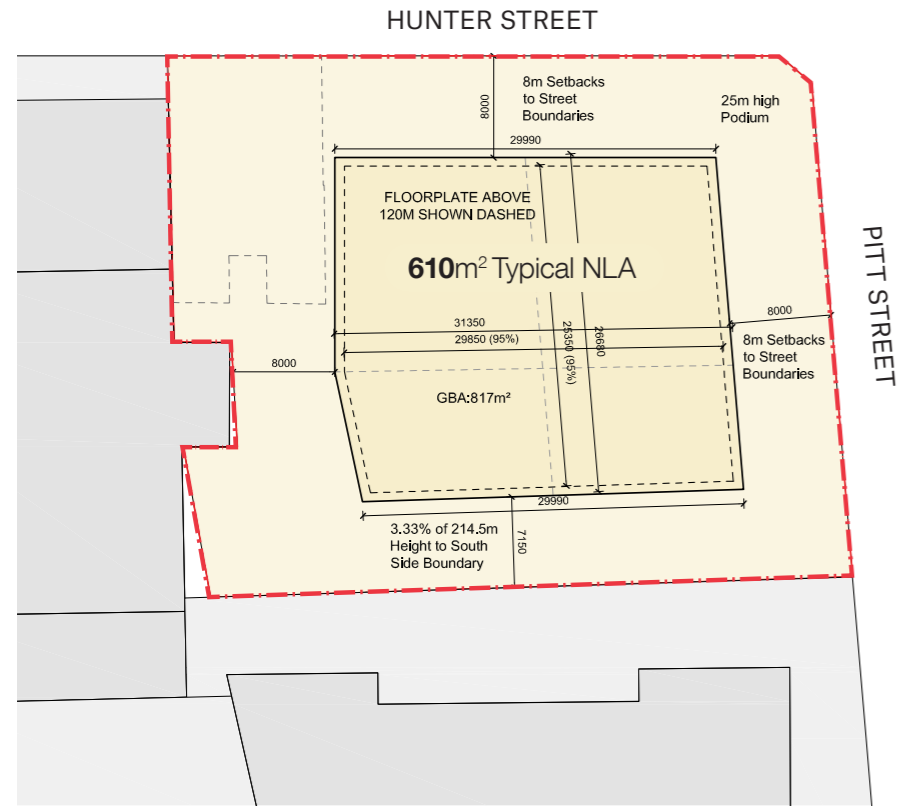

SCHEDULE 11 ENVELOPE TOWER SETBACKS

Pitt Street	8m
Hunter Street	8m
Western Boundary	8m
Southern Boundary	7.15m

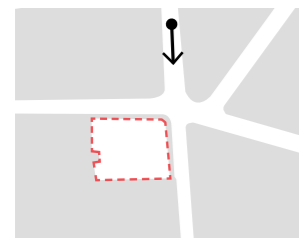

VIEW 4 - Looking south along Pitt Street



COMPARATIVE PEDESTRIAN VIEW ANALYSIS

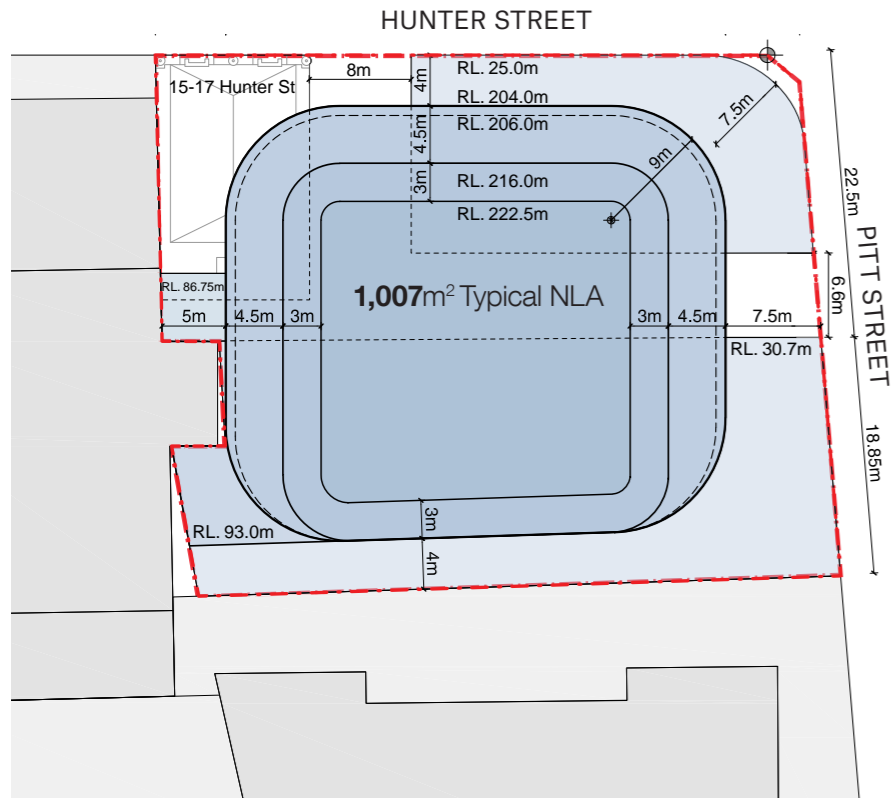

PROPOSED ENVELOPE TOWER SETBACKS

33 Pitt Street	7.5m average
Hunter Street	4m
Western Boundary	5.5m max.
Southern Boundary	4m

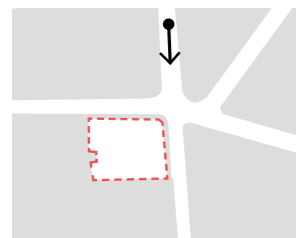

VIEW 4 - Looking south along Pitt Street



COMPARATIVE PEDESTRIAN VIEW ANALYSIS

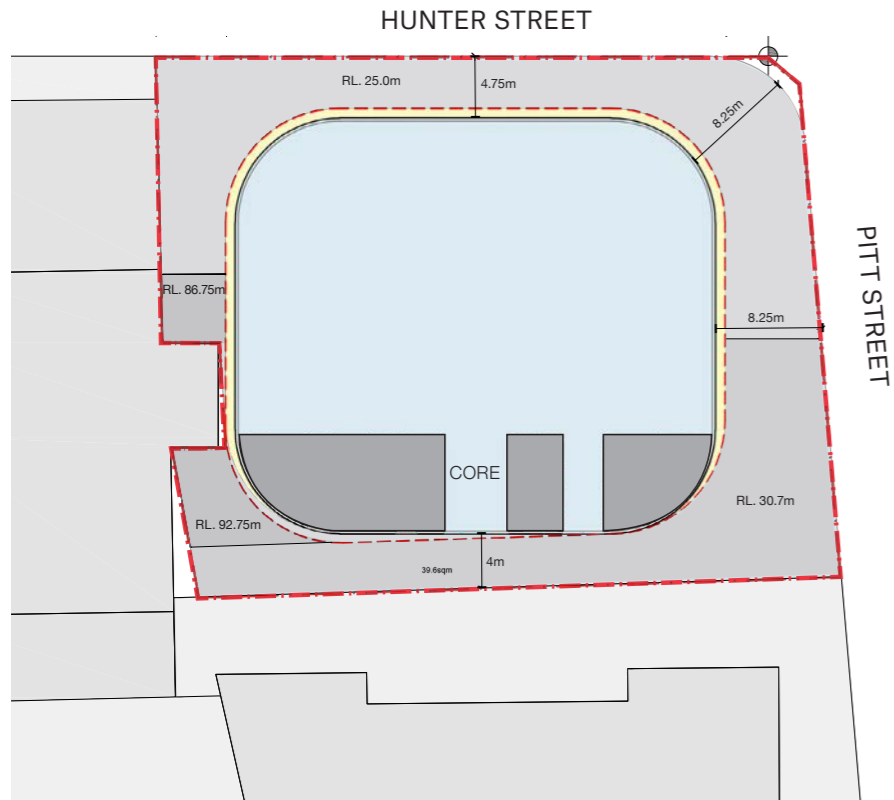

REFERENCE DESIGN TOWER SETBACKS

Pitt Street	8.25m average
Hunter Street	4.75m
Western Boundary	6.25m max.
Southern Boundary	4m

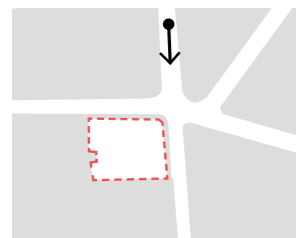

VIEW 4 - Looking south along Pitt Street



COMPARATIVE PEDESTRIAN VIEW ANALYSIS

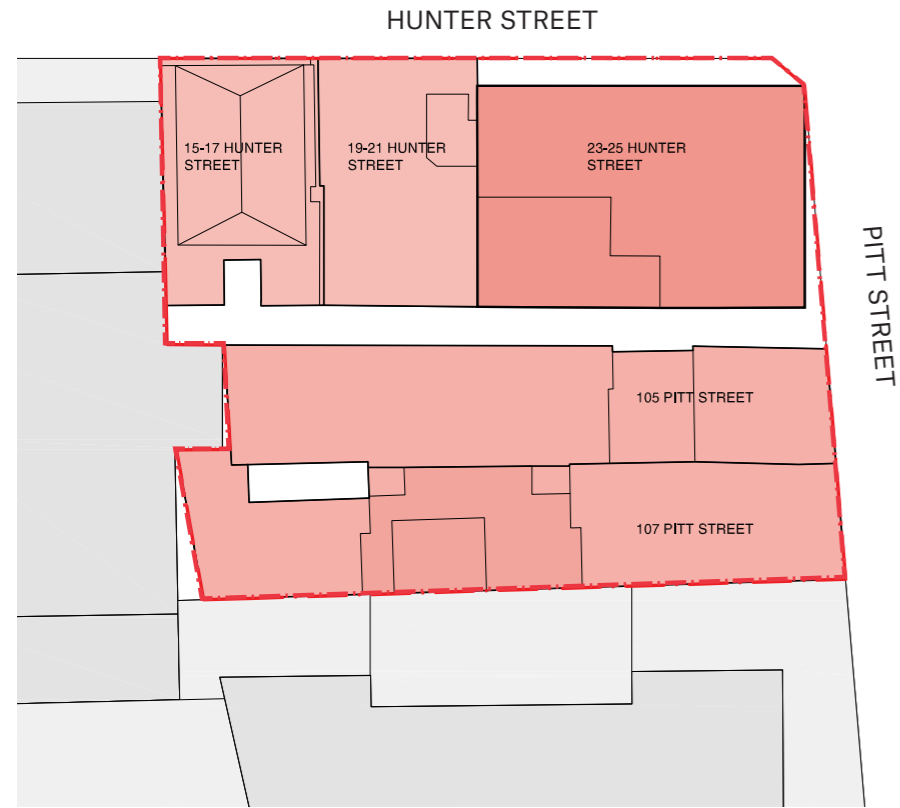

EXISTING SITE CONTEXT

335

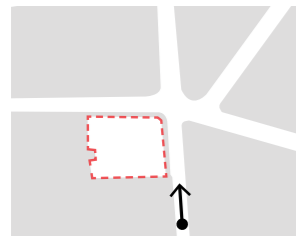

VIEW 5 - Looking north along Pitt Street



COMPARATIVE PEDESTRIAN VIEW ANALYSIS

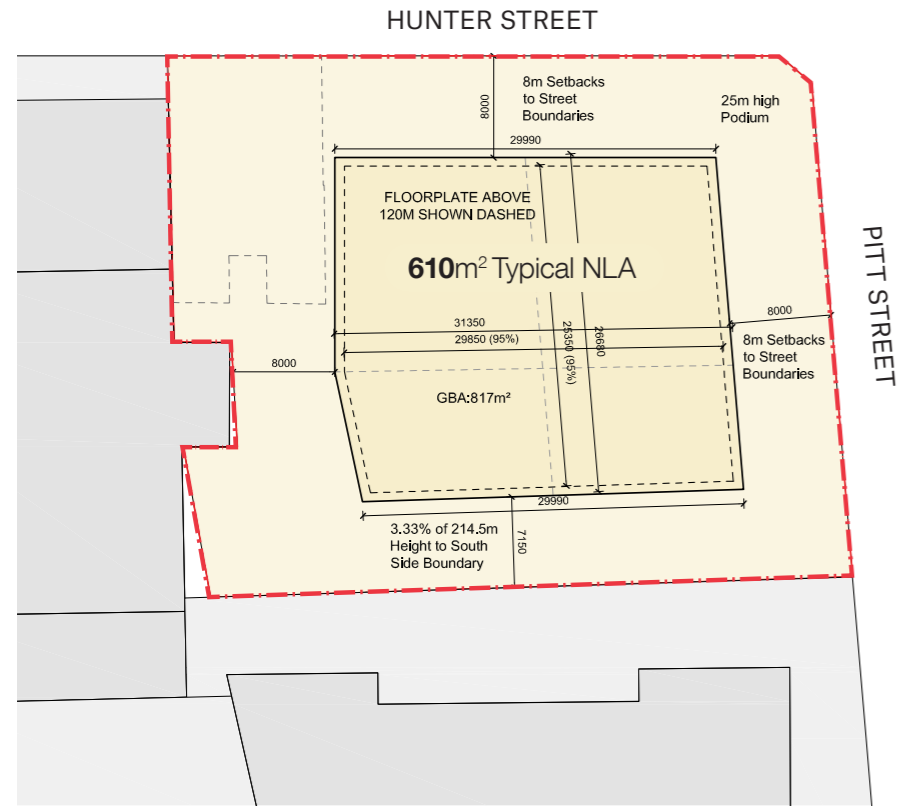

SCHEDULE 11 ENVELOPE TOWER SETBACKS

Pitt Street	8m
Hunter Street	8m
Western Boundary	8m
Southern Boundary	7.15m

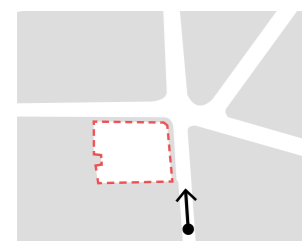

VIEW 5 - Looking north along Pitt Street



COMPARATIVE PEDESTRIAN VIEW ANALYSIS

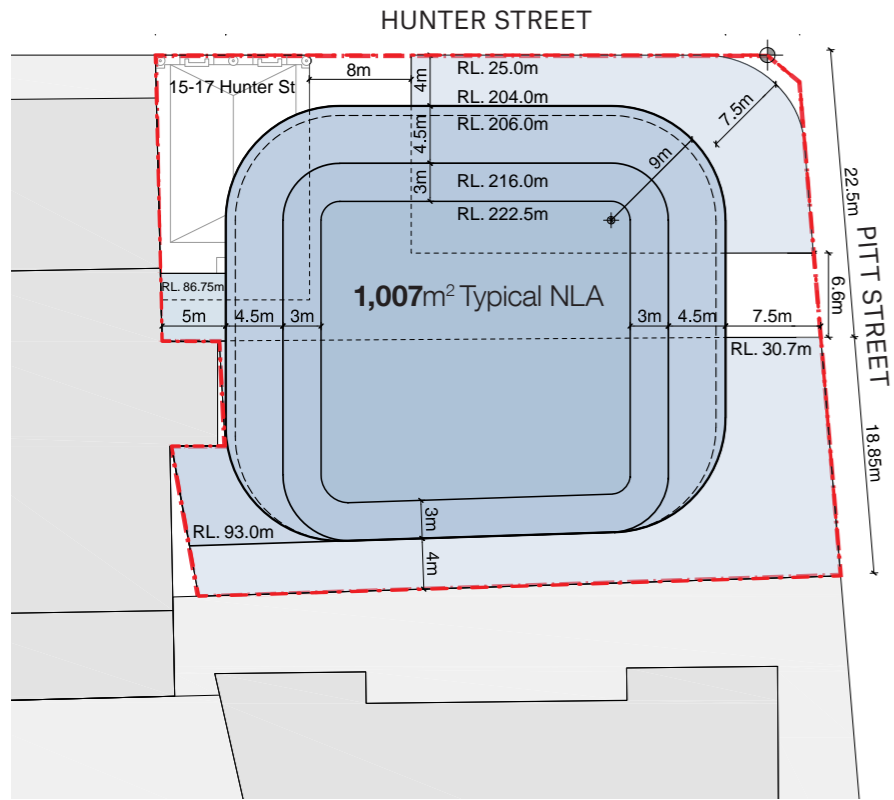

PROPOSED ENVELOPE TOWER SETBACKS

337 Pitt Street	7.5m average
Hunter Street	4m
Western Boundary	5.5m max.
Southern Boundary	4m

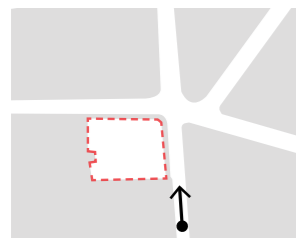

VIEW 5 - Looking north along Pitt Street



COMPARATIVE PEDESTRIAN VIEW ANALYSIS

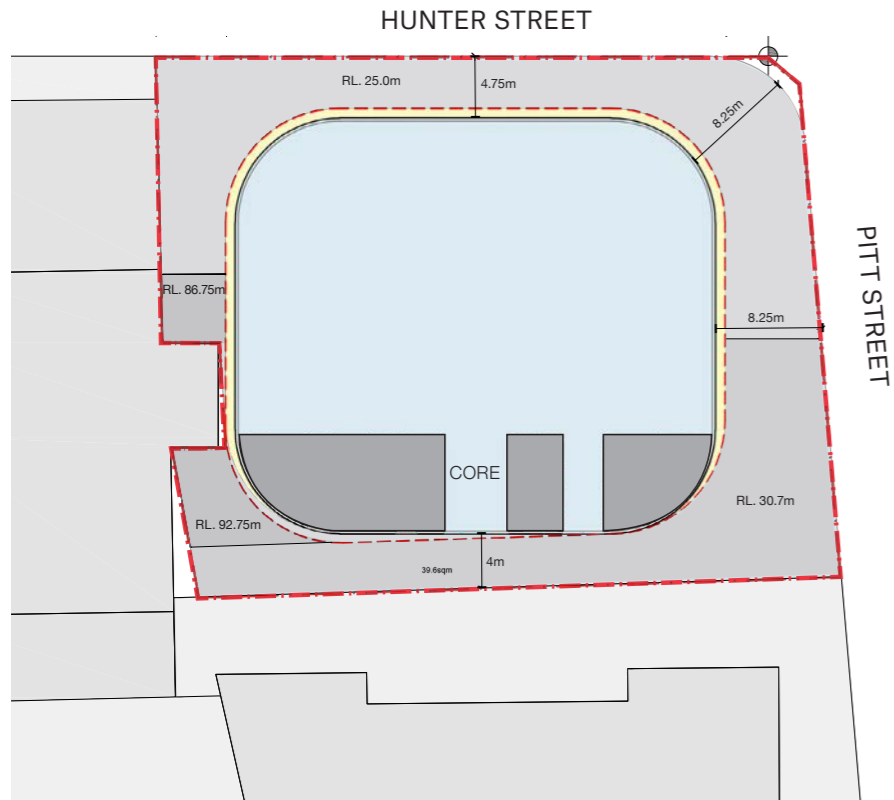

REFERENCE DESIGN TOWER SETBACKS

33 Pitt Street	8.25m average
Hunter Street	4.75m
Western Boundary	6.25m max.
Southern Boundary	4m

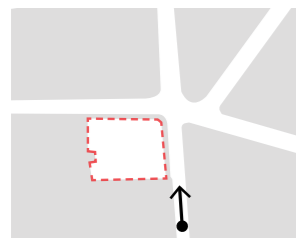

VIEW 5 - Looking north along Pitt Street



Appendix B

Additional Information

15-23 Hunter Street and
105-107 Pitt Street Sydney

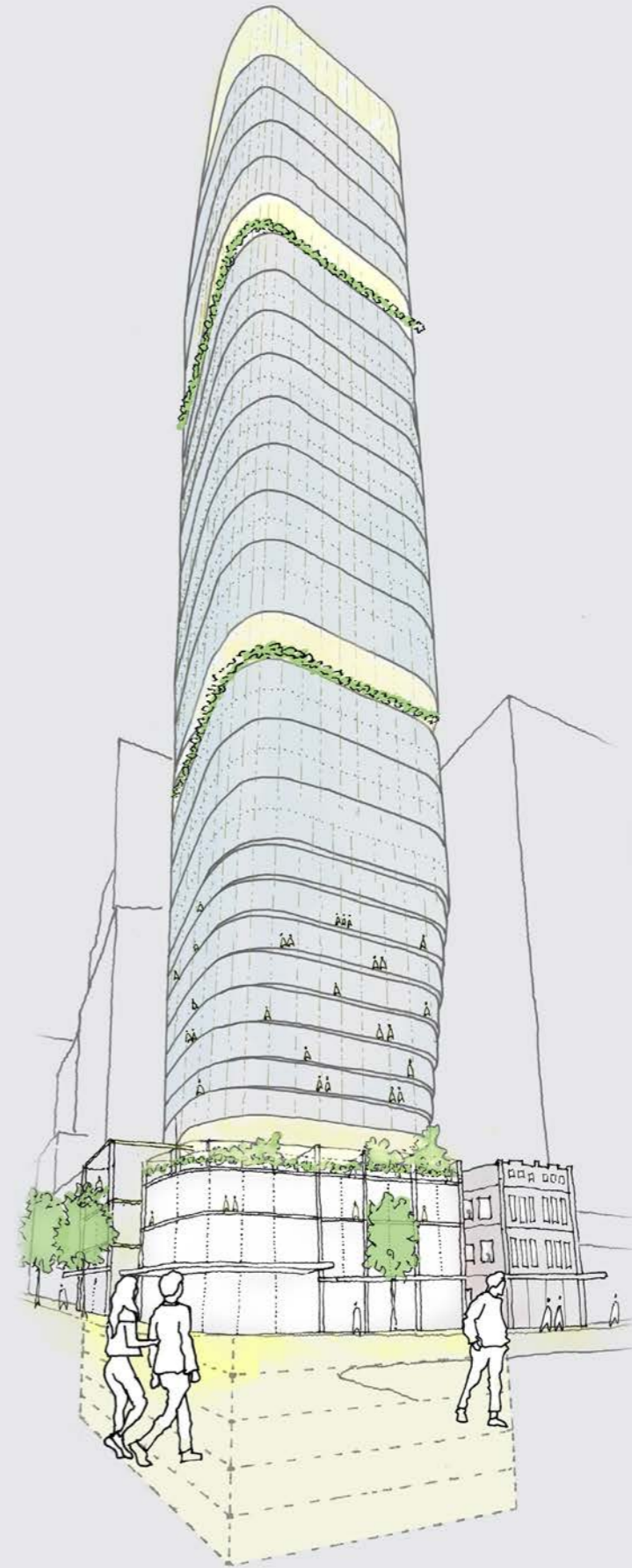

10.1 Building Articulation Study

The following images and diagrammatic plans have been prepared to aid discussion of the appropriate requirements for facade zone depth & articulation allowance for this particular site. They illustrate possible massing outcomes with a 750mm supplied facade zone in addition to 6% architectural articulation.

OPTION 1:

- 750mm Facade Zone to North
- Closed Cavity facade to East, West and South
- Balance of Architectural Articulation plus Facade Zone equates to the same overall GFA as other options.

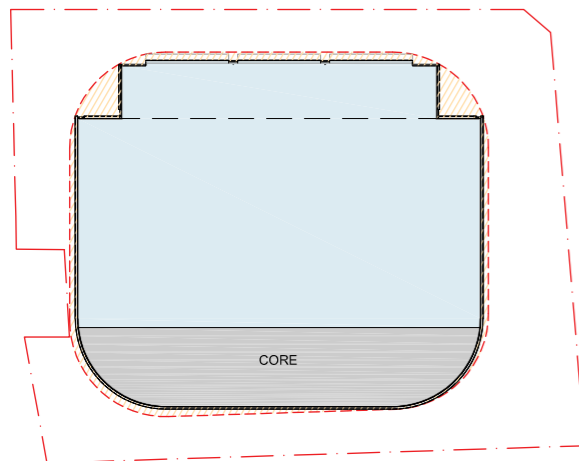

OPTION 1 - TYPICAL PLAN



OPTION 1
Orthogonal corners

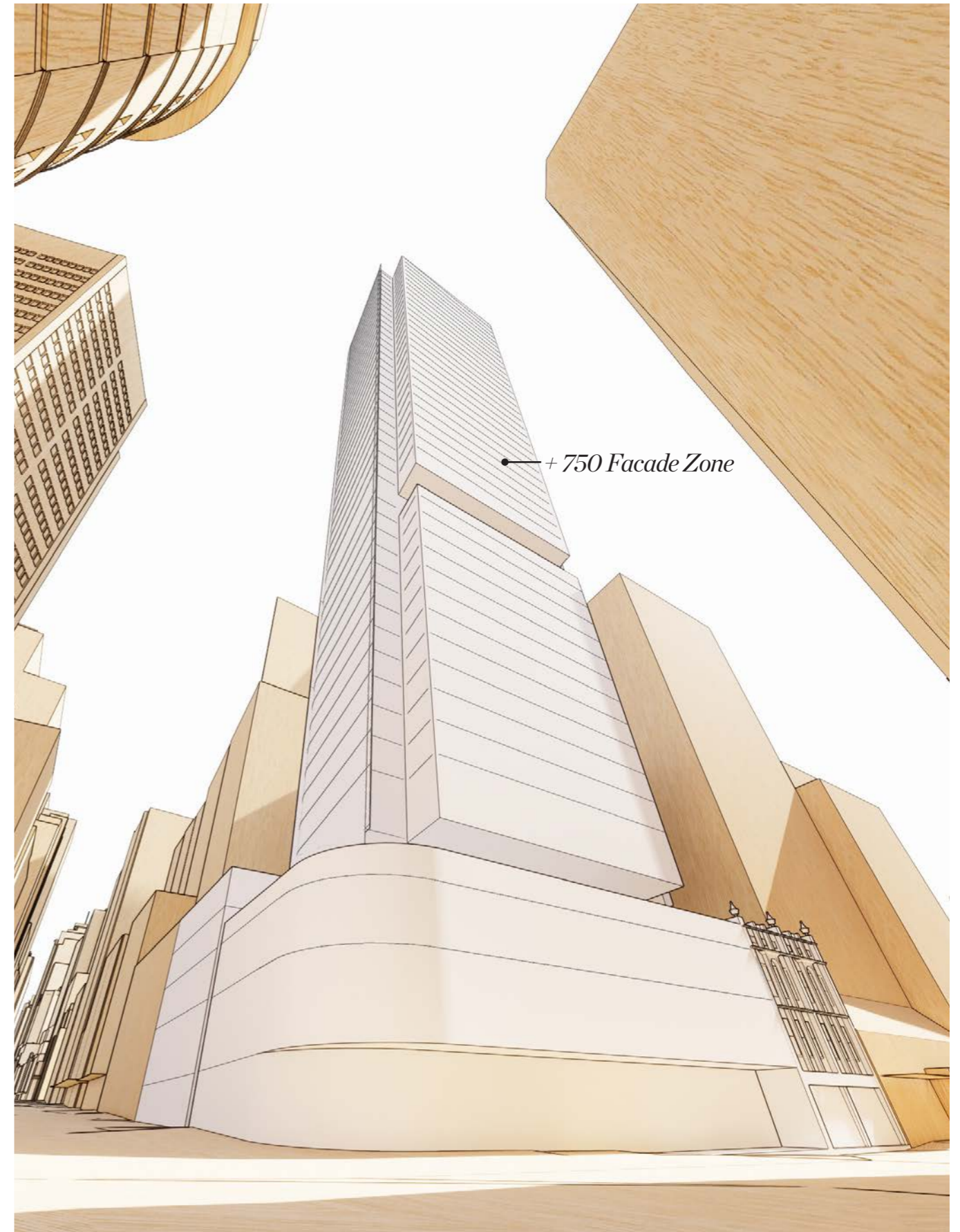

OPTION 2:

750mm Facade Zone to North, East, and West
+ 6% of GEA for Architectural Articulation

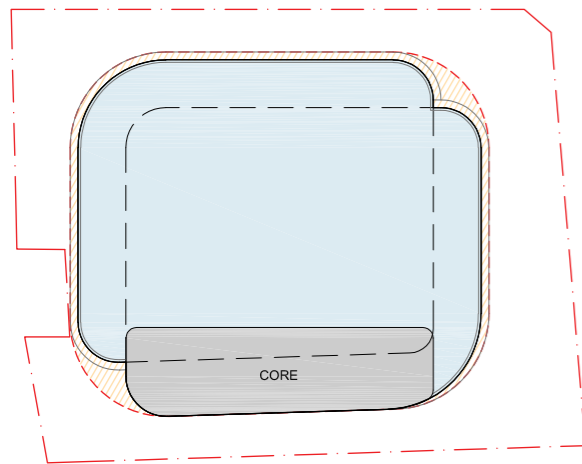

OPTION 2 - TYPICAL PLAN



OPTION 2
Interlocking Volumes

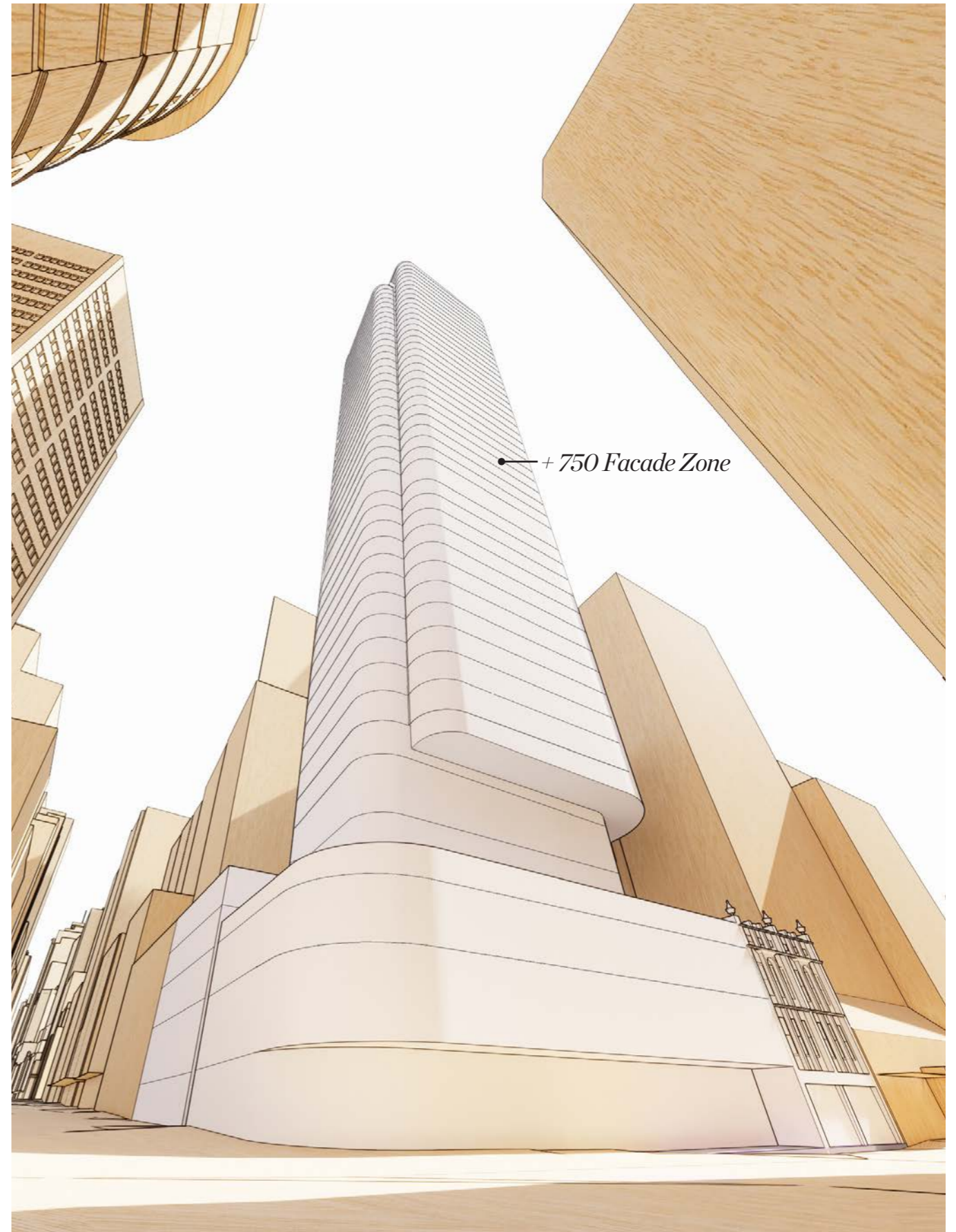

34

OPTION 3:

750mm Facade Zone to North, East, and West
+ 6% of GEA for Architectural Articulation

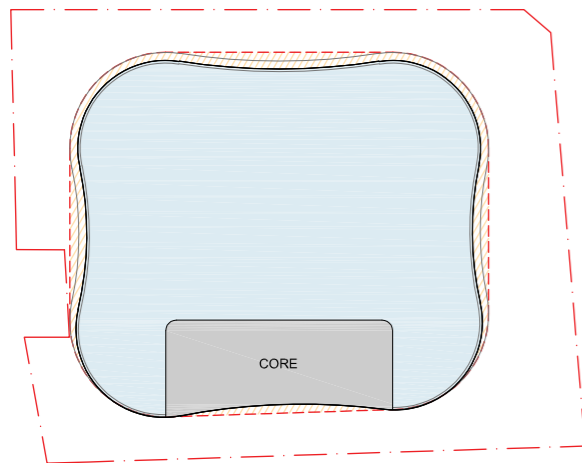

OPTION 3 - TYPICAL PLAN



OPTION 3
Undulating



34

OPTION 4:

750mm Facade Zone to North, East, and West
+ 6% of GEA for Architectural Articulation

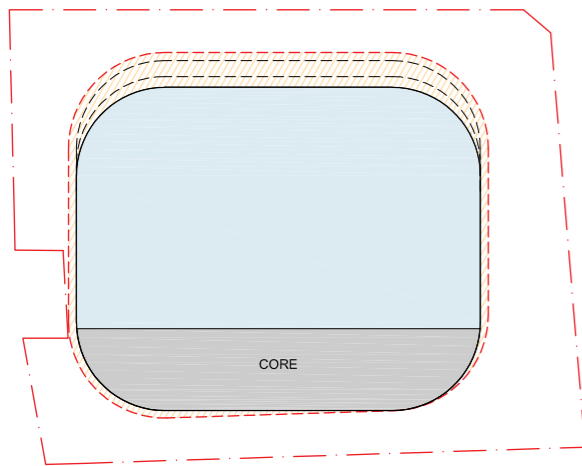

OPTION 4 - TYPICAL PLAN



OPTION 4
Tapers at bottom

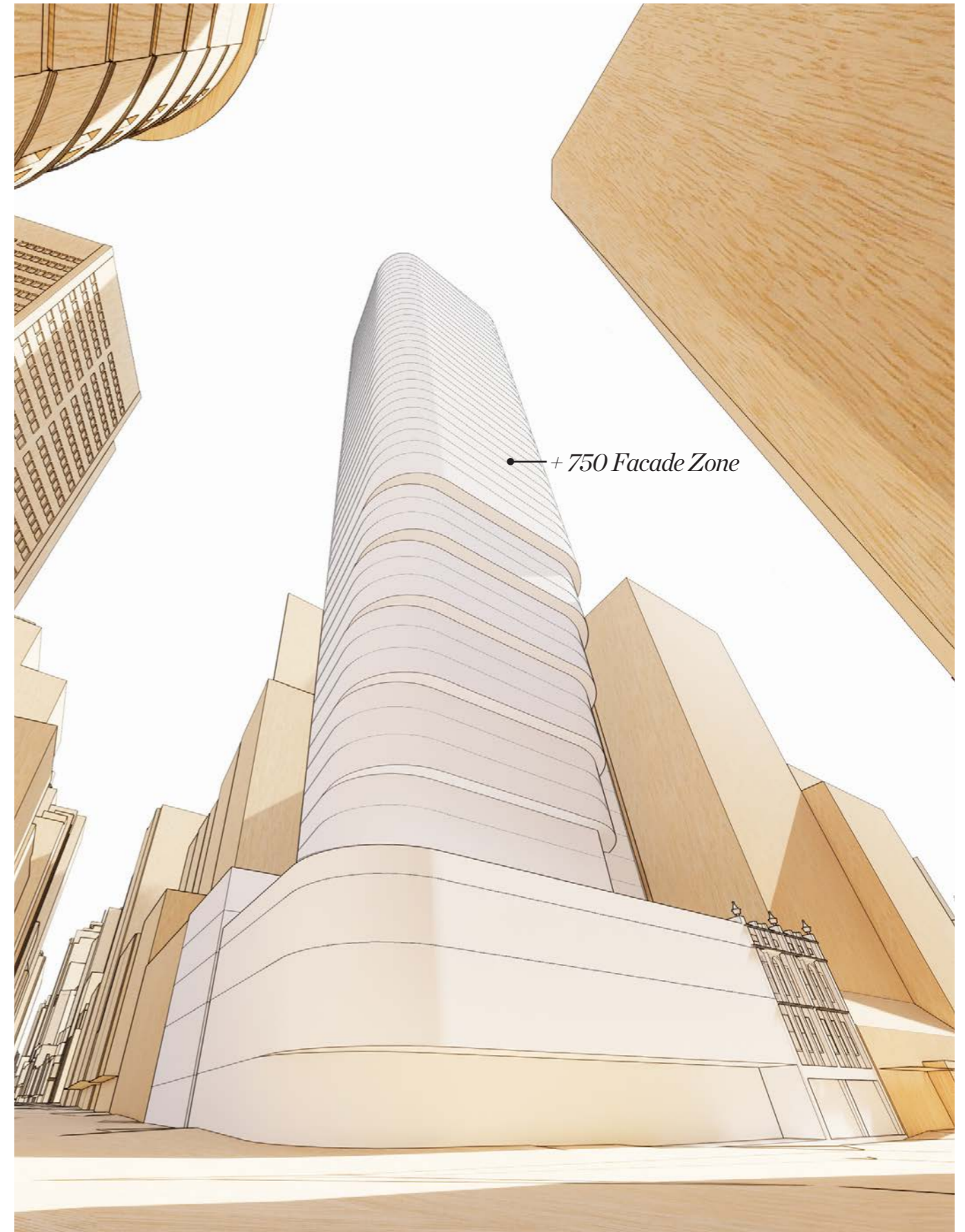

3/4

REFERENCE DESIGN:

750mm Facade Zone to North, East, and West
+ 6% of GEA for Architectural Articulation

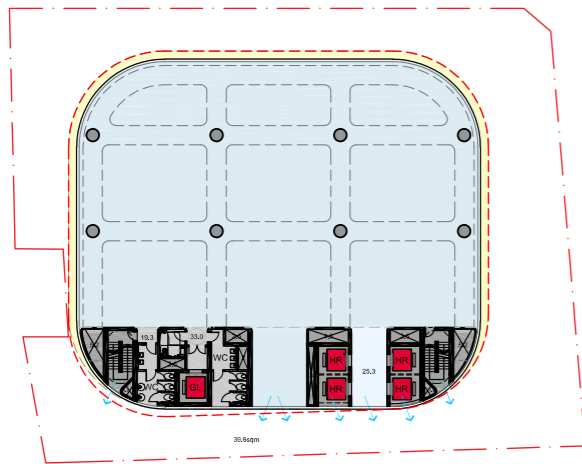

REFERENCE DESIGN - TYPICAL PLAN



REFERENCE DESIGN
Stacked Volumes



10.2 Tall Towers

Effect of Tower Shape

The plan shape of a tower will greatly influence the wind loading to be resisted as well as the dynamic response and accelerations. Below presents in very simple terms the relative 'drag factors' for different shapes. As a general rule:-

- A square shape is not ideal
- Sharp corners are best avoided.
- Chamfered or rounded corners greatly reduce wind loading.
- Overall rounded forms typically behave better.



The shape of a tower in elevation is also a factor in influencing its performance under wind. In the case of tall towers, or towers with high slenderness, departure from a pure extruded form can greatly improve the dynamic response by 'confusing the wind' and reducing the effects of vortex shedding. A gentle taper over the height of the building is effective in this respect, or as an extreme, a non-symmetric elevational profile. The world's tallest tower, the Burj Khalifa in Dubai, uses this latter effect to benefit the performance of the tower and the comfort of occupants within.

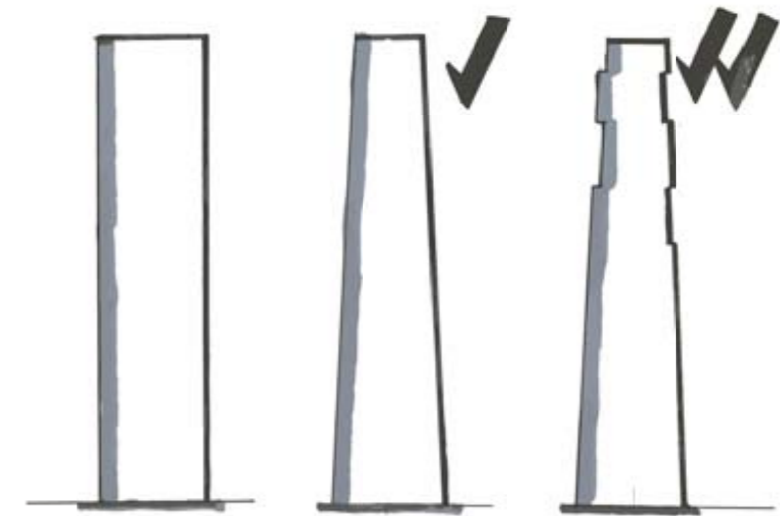

345

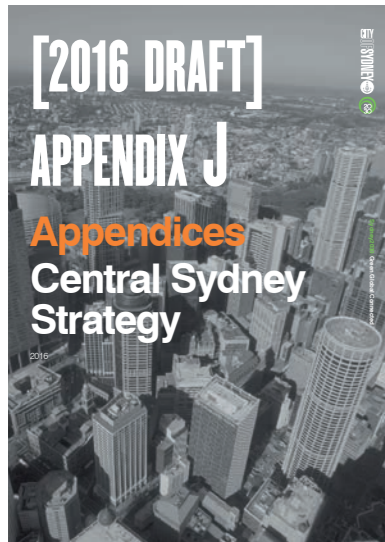

Source: Central Sydney Planning Strategy prepared by The City of Sydney

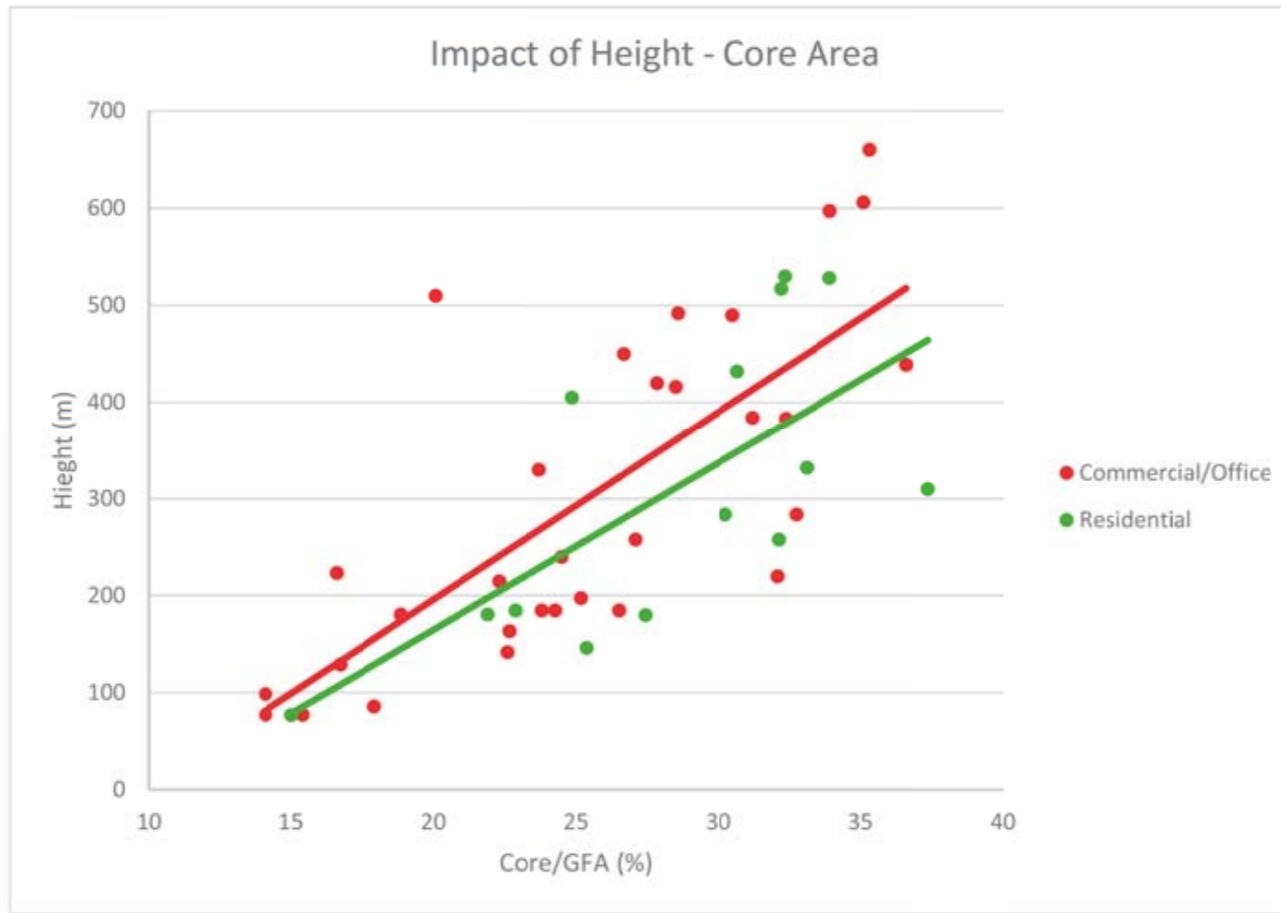

The above data comes from Arups database on towers in Asia. It comprises a range of structural systems (influenced by height) and also includes mixed use towers. The core area shown is that for the low levels of the tower, as opposed to that in the higher levels where the lifts 'drop-off' and core sizes typically reduce.

Cores Sizes

The size of cores for tall buildings vary significantly depending on the approach to vertical transportation, escape stairs and how the building is serviced. While the core will typically make a significant contribution to the strength and stiffness of the tower, invariably its size is dictated by the space requirements of the services and egress provision within. Indicative breakdown of services within the core for high rise commercial tower are as follows:

	Approx Percentage of floor plate area	Approx percentage of core Area
Building Services	3.5%	10.5%
Fire stair	2.0 %	7%
Lifts	10.5 %	35%
Lobbies	8 %	24%
WCs	2.5 %	8%
Total	26.5 %	85%

The figures above exclude the 'structure' of the core. It is for this reason that the total is 85%. The residual area making up the core can be considered as structure and miscellaneous.

Plant floors

Typically there will be a plantroom every twenty (20) to twenty eight (28) floors. Plant floors will typically be between 5.5m and 6.0m floor to floor. Total building services plant requirement will be between 9.5 and 10.0% of gross floor area (GFA). Depending on the specifics of the design, there could be two plant floor levels at 20-28 storey intervals, and it may be that the floor to floor height matches that of the typical floors (for reasons of external aesthetics).

External skin allowances

For typical towers NLA is measured to the inside face of the glazing. Overall glazing thickness is typically 30mm for a high rise tower.

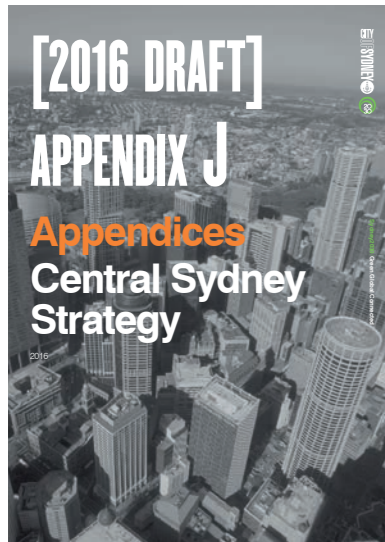

Source: Central Sydney Planning Strategy prepared by The City of Sydney

Tall Buildings | The implications of increasing height

Tall Buildings | The Implications of Increasing Height

Impact of height

Typical Building Services Systems

Mechanical

Key issues in the consideration of mechanical systems:

- Air verses chilled water circulation
- Central plant
- Efficiency of risers sizing
- Stack Effect issues.
- Environmental impact on the design.
- Plant replacement and maintenance.
- Tenant plant flexibility.

Mechanical Plant (Commercial Buildings)

Taller buildings are more energy intensive and require more power the taller the building becomes. The graphs on the right show the typical floor area requirements for different mechanical systems. One is all water system (eg. chilled beam approach) where as the other is all air without water on the office floors (eg. Variable Air Volume (VAV) approach).

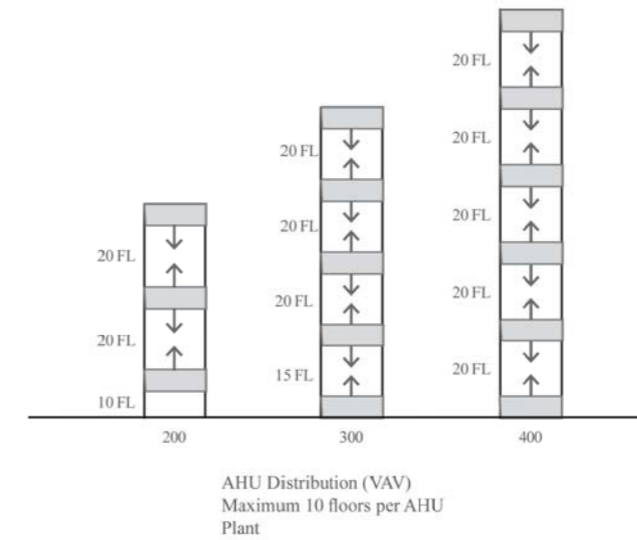
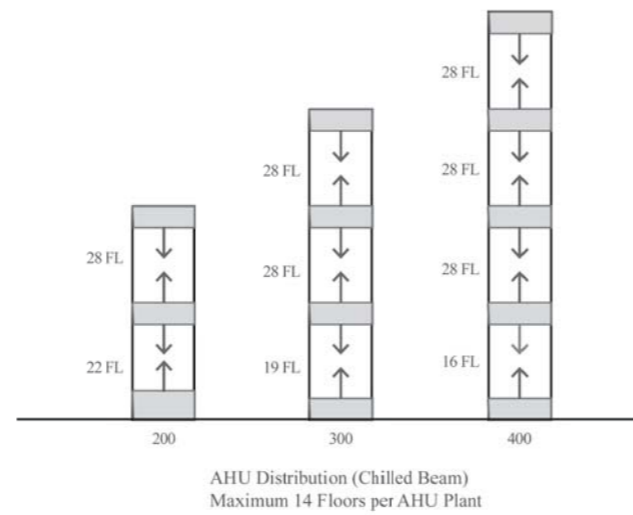

Vertical Risers

Typically as follows:

1. Mechanical Air - No variation with height assuming distributed plant.
2. Mechanical Water - Negligible difference albeit minor penalty due to hydraulic break.
3. Electrical - Penalty with height to reticulate HV up the building and communications.
4. Fire Services and Hydraulics - Penalty with height for multiple rising mains.

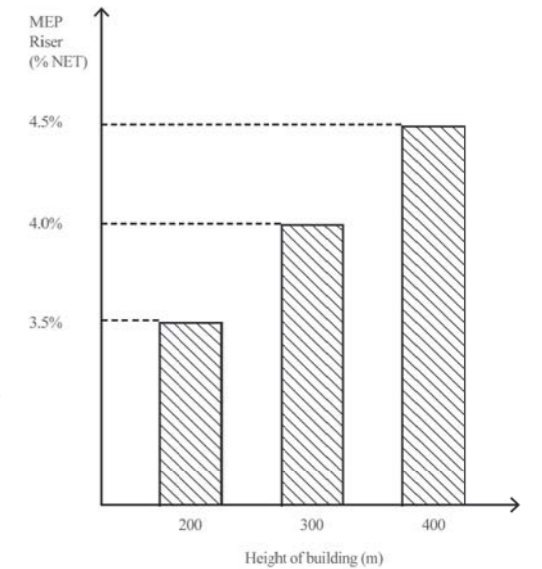

Total typical area of risers as a percentage of floor area.

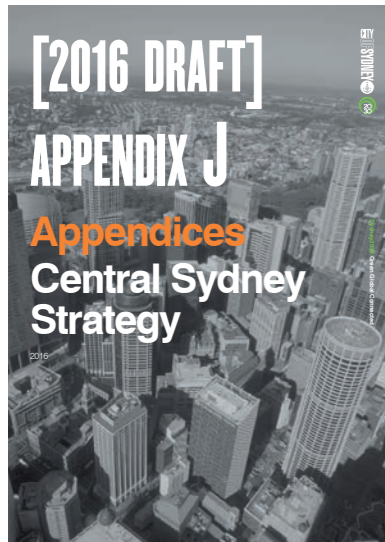

Source: Central Sydney Planning Strategy prepared by The City of Sydney

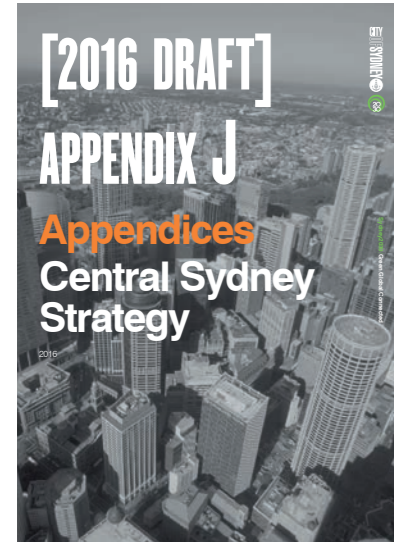

Source: Central Sydney Planning Strategy prepared by The City of Sydney

Tall Buildings | The Implications of Increasing Height

Impact of height

Design Arrangements (Stacking)

As towers increase in height, the vertical transportation design must respond to achieve the required performance and enable the seamless flow of tenants and visitors throughout the building.

While increasing the number, size and speed of elevators is possible, there comes a point where this is no longer an effective design strategy in order to maintain the floor plate efficiencies required to make a development viable. At this point the design of vertical transportation systems must adopt design strategies and equipment technologies different to those the Sydney market may be familiar with.

To maximise floor plate efficiencies elevators are arranged in groups. Subject to the number of elevators in each group (low, mid, high rise etc) the below stacking arrangements are typical.

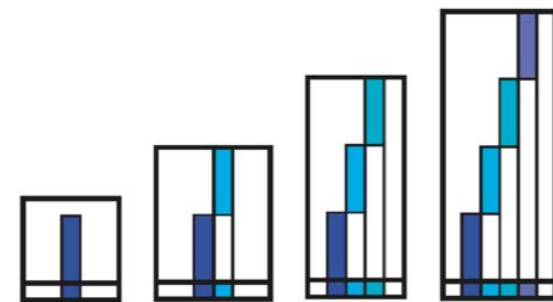

1 group of lifts services approximately 20 floors
 2 groups of lifts services approximately 20 - 35 floors
 3 groups of lifts services approximately 30 - 45 floors
 4 groups of lifts services approximately 40 - 55 floors

As commercial towers increase in height or where mixed use towers are being developed, sky lobbies can be introduced as depicted below. Sky lobbies require the use of shuttle elevators to transport passengers to the sky lobby where they transfer to local elevator groups.

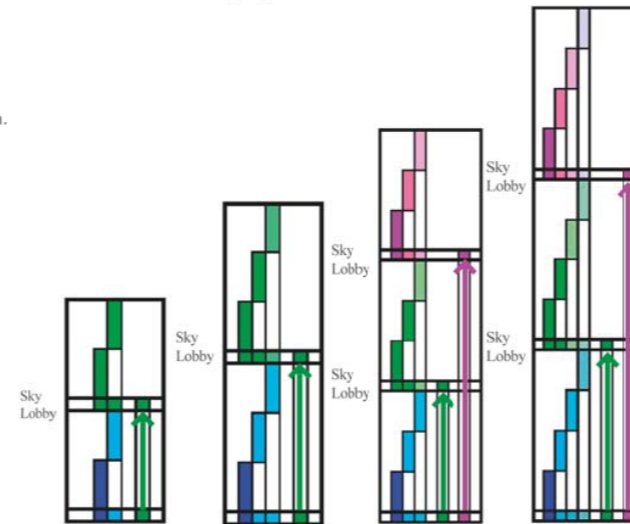

Approximately 55 - 80 floors
 > 80 floors

- Sky lobbies can provide a number of design benefits to the development such as:
- Increased core efficiency by stacking "local passenger elevators" atop each other.
 - Ability to quickly transport a large percentage of the buildings occupants.
 - A location for social amenity particularly in residential towers where a local township can be created.
 - A line of security between commercial, residential & hotel components of mixed use developments.
 - In comparison to a conventional single deck system with all elevators serving from the ground floor, sky lobbies can reduce the core size by up to 25%.

Equipment Technology

As towers increase in height, it is necessary to consider the use of various equipment technologies to achieve the required performance levels. There are several equipment technologies that have been specifically developed to maximise the handling capacity of each elevator shaft. These include:

- Multi-car systems (Double Deck and TWIN Elevators)
- Destination Control Service

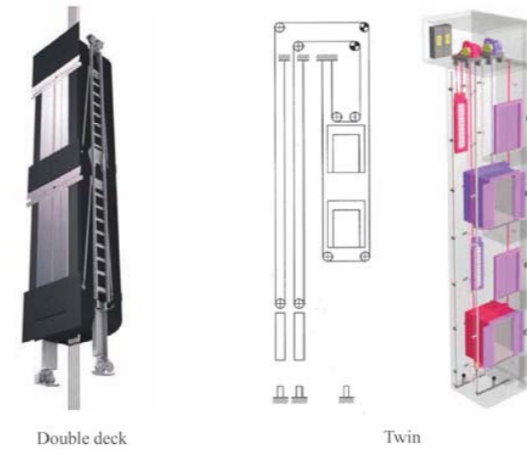

Double Deck elevators comprise two permanently connected passenger cars, positioned one above the other and connected to a common suspension and drive system. The upper and lower decks are therefore limited to serving two adjacent floors simultaneously.

The Twin system is unique to ThyssenKrupp and has 2 elevator cars running independently in the same elevator shaft. Each car has its own ropes, counterweight, safety, control and drive equipment while sharing common guide rails and landing entrance doors.

Multi-car elevator systems have been specifically developed to increase the handling capacity of each elevator shaft. This in turn provides the opportunity to reduce the overall number of elevator shafts while achieving comparable levels of service to a traditional single deck system.

There are a number of similarities between Double Deck and TWIN elevator systems, with the most important being:

- Both require Destination Control Service to maximise efficiencies. On Double Deck elevators, DCS is used to minimise non-coincidental calls and on Twin to maintain safe operational distances between elevator cars;

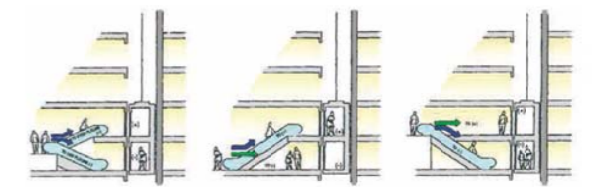

- Both require dual lobby loading to allow the upper and lower cars to load simultaneously;
- Increase handling capacity of each elevator shaft;
- Fewer elevator shafts;
- In comparison to a conventional single deck system with all elevators serving from the ground floor, the use of multicar elevator systems combined with sky lobbies can reduce the core size by up to 35%.

When considering a multi-car vertical transportation system in conjunction with the use of sky lobbies the below stacking arrangements are made possible.

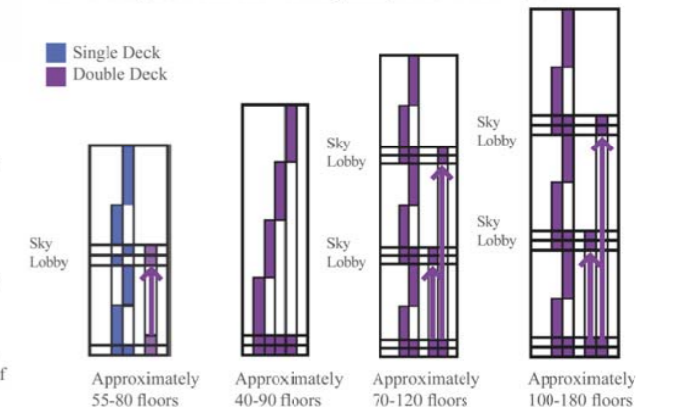

10.3 Survey

349

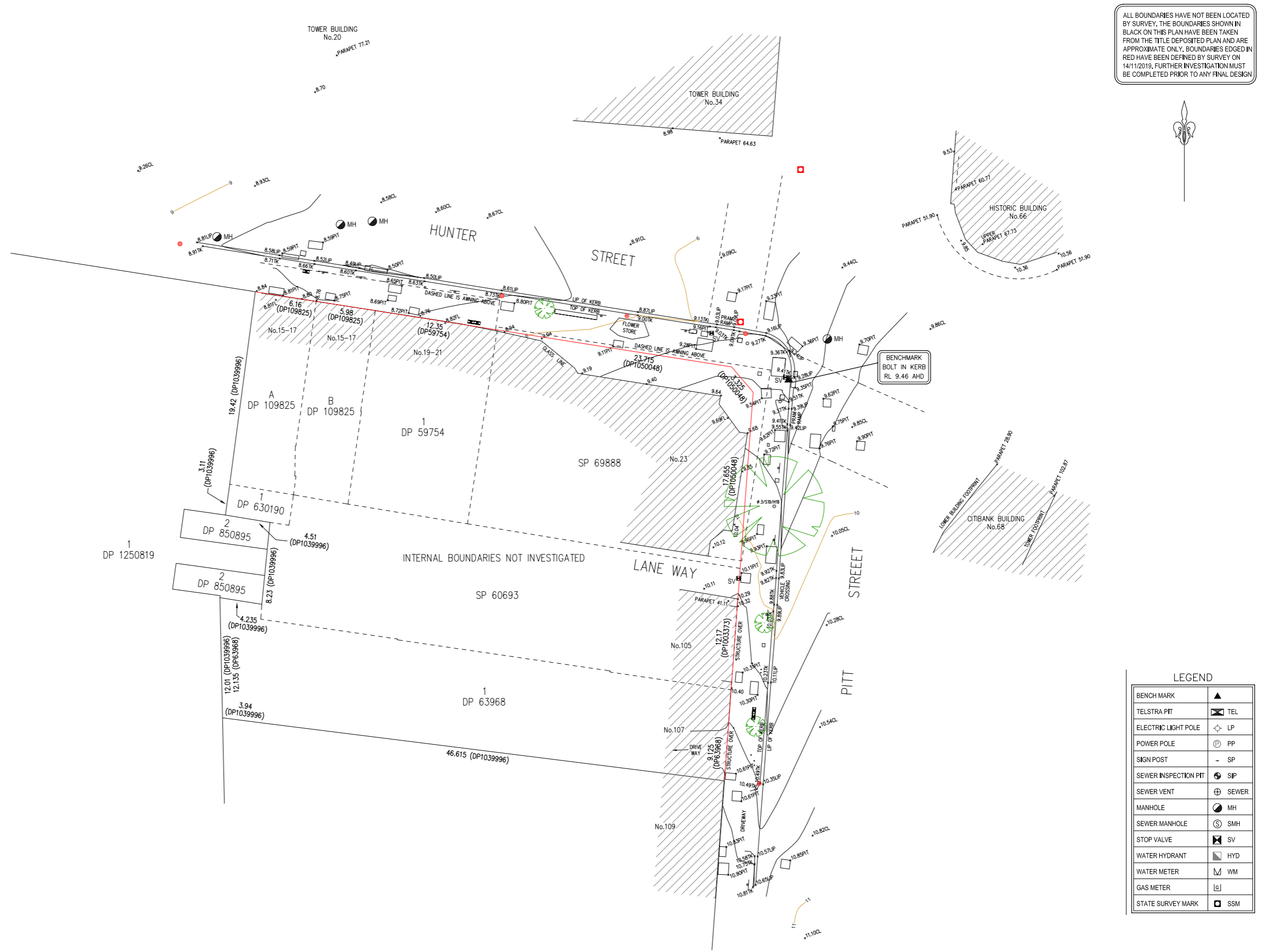

ALL BOUNDARIES HAVE NOT BEEN LOCATED BY SURVEY. THE BOUNDARIES SHOWN IN BLACK ON THIS PLAN HAVE BEEN TAKEN FROM THE TITLE DEPOSITED PLAN AND ARE APPROXIMATE ONLY. BOUNDARIES EDGED IN RED HAVE BEEN DEFINED BY SURVEY ON 14/11/2019. FURTHER INVESTIGATION MUST BE COMPLETED PRIOR TO ANY FINAL DESIGN



LEGEND	
BENCH MARK	▲
TELSTRA PIT	TEL
ELECTRIC LIGHT POLE	LP
POWER POLE	PP
SIGN POST	SP
SEWER INSPECTION PIT	SIP
SEWER VENT	SEWER
MANHOLE	MH
SEWER MANHOLE	SMH
STOP VALVE	SV
WATER HYDRANT	HYD
WATER METER	WM
GAS METER	GM
STATE SURVEY MARK	SSM

BATES SMAR  **TSS TOTAL SURVEYING SOLUTIONS**
LANE COVE | CAMDEN | MANLY VALE | CENTRAL COAST

REVISION No.	REVISION DATE:	COMMENT:
15-23 HUNTER STREET AND 105-107 PITT STREET JUNE 2022 PLANNING PROPOSAL		

LEGEND	
EB - EDGE OF BITUMEN	TG - TOP OF GUTTER
EC - EDGE OF CONCRETE	RR - ROOF RIDGE
FL - FINISH LEVEL	FL - FINISH LEVEL
BB - BOTTOM OF BANK	INV - INVERT LEVEL
TW - TOP OF WINDOW	ELEC - ELECTRICAL PIT
BW - BOTTOM OF WINDOW	Ø, I/S Ø/H I/S - DIAMETER/SPREAD/HEIGHT

PLAN SHOWING DETAIL & LEVELS
AT THE CORNER OF PITT STREET AND HUNTER STREET

CLIENT: MILLIGAN GROUP
PROJECT: SYDNEY
ADDRESS: CORNER PITT & HUNTER, SYDNEY

PLOTTED SCALE 1:200 (A1 SIZE SHEET)

JOB No.: 192625	LGA: SYDNEY
PLAN No.: 192625-1	DATUM: AHD
DATE: 15/11/2019	SCALE: 1:200@A1 172
DRAWN: RA	CONT. INTERVAL: 0.25m
CHK: WH	SHEET 1 OF 1

William Hamer
Registered Surveyor
Nº 1606